

THE PROPERTY OF THE DRAWING IS ESTABLISHED BY LAW. IT IS FORBIDDEN TO PRODUCE OR SHOW IT TO THIRD PARTY, WITHOUT A WRITTEN AGREEMENT.

Item	Name	Q.ty
1	CA.08.14.014	1
2	CA.GWP.5.10	1
3	R.5.SCH	2
4	V.TCE5x16	2
5	WSS.X.18.18	1

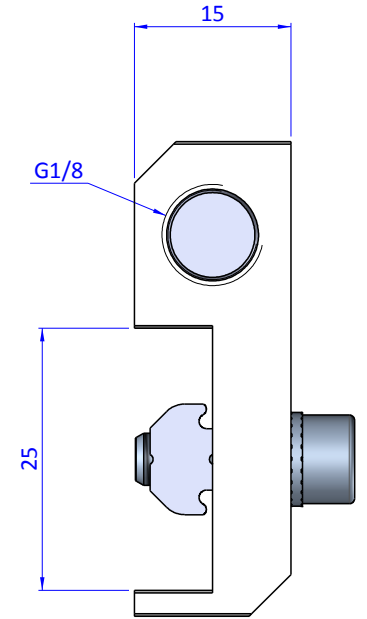
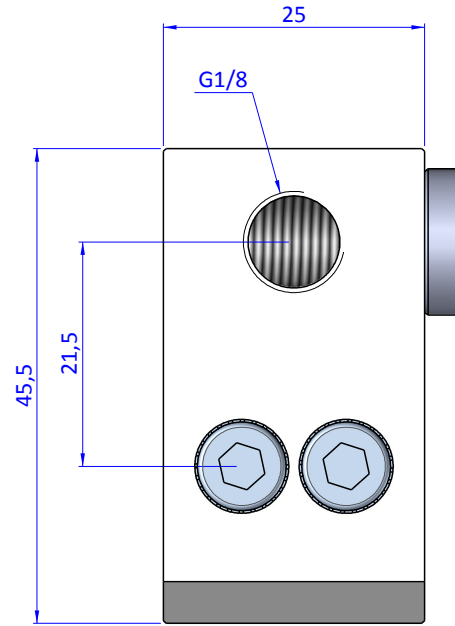
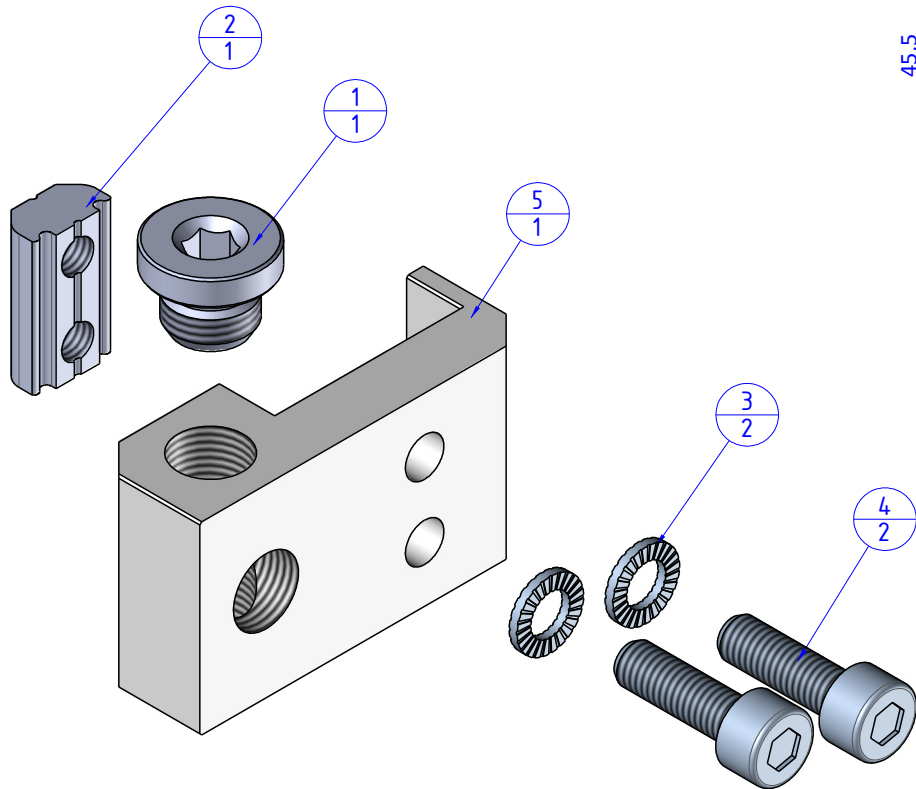

Format A3

UNI 936-76

		DESIGNED FROM		REVIEW
		FPSERVICES		A
GENERAL TOLERANCE		DATE	WEIGHT	
UNI - ISO 2768		28/02/2019	0,050kg	
CLASSE f		CODE		
		CA.WSS.X.18.18		CA.WSS.X.18.18